

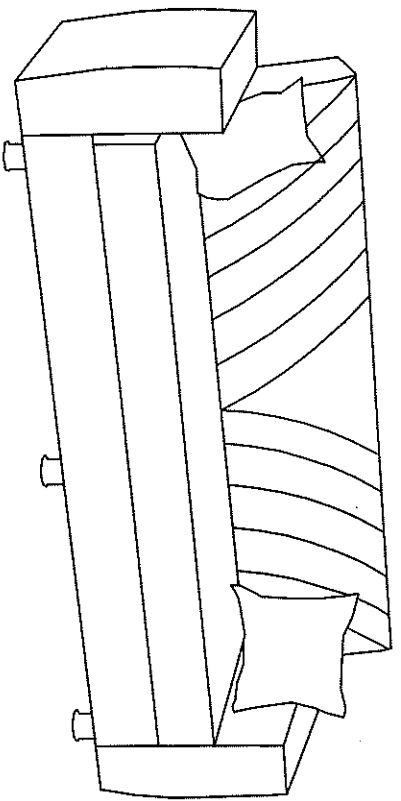



# DAVIS ASSEMBLING INSTRUCTION



## PACKAGE DESCRIPTION

- \* LEG (5) \_\_\_\_\_ 
- \* SCREW (6) \_\_\_\_\_ 
- \* BINDING PART (6) \_\_\_\_\_ 

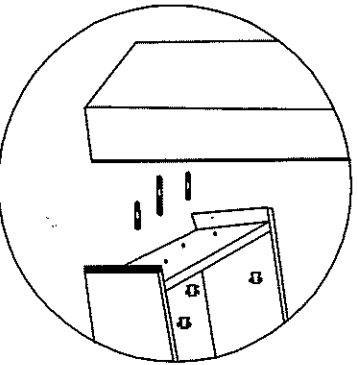
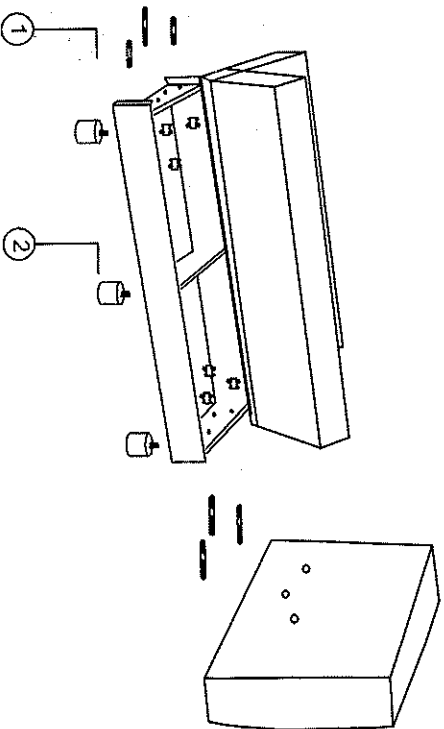
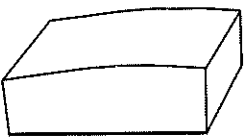

1. ASSEMBLING OF ARM

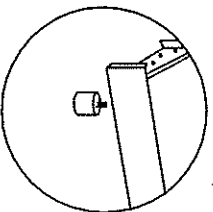

2. ASSEMBLING OF LEGS